

# **Ferlin**

plastics automation

## **IMPROVING PLASTICS *TOGETHER***

### **USE AND MAINTENANCE MANUAL FOR HONEY CUMB DEHUMIDIFIER TYPES OF MACHINE**

**FED 15/30(HT)  
FED 20/50(HT)  
FED 25/75(HT)  
FED 30/100(HT)**

## **PREMISE**

*This manual was drawn up with the intention of providing operators with the right information for proper use and maintenance of the machine. It is therefore essential to carefully read the manual, in its entirety, in order to prevent any inconvenience that could compromise proper operation or possibly cause irreparable damage to the machine. The use of these components is prohibited on all materials other than plastics in non-toxic granules (eg powdered plastics, explosive mixtures, flammable, harmful and food products).*

*Here are some general points which are recommended to be followed:*

- *we recommend that you read this manual entirely before carrying out any maintenance operations and before using the machine for the first time.*
- *the machine is equipped with all the safety devices essential for checking operation and preventing possible accidents. However, these devices tend to prevent injury but not to exclude it. In no case, therefore, must dangerous manoeuvres be carried out without first making sure that the safety devices are in perfect working order and that you are operating in completely safe conditions.*
- *the machine must not be used for purposes other than those for which it was designed and built.*
- *this manual contains the technical characteristics and work performance provided by the machine. These services must not be changed.*
- *the performance and good operation of the machine are guaranteed if the connections to the electrical, pneumatic and water networks always comply with the power supply characteristics and the connection methodology reported in this booklet.*
- *the user must be perfectly familiar with the technical and operating characteristics of the machine. Any problems or faults generated by incorrect use and maintenance will invalidate the warranty conditions. The manufacturer is relieved of all responsibility even in the event that the units it produces are not used for the intended uses.*

*The copyright of these instructions for use, descriptions, drawings and attachments remains the property of the manufacturer and can be duplicated or made accessible to third parties only after express authorization from manufacturer.*

INDEX .....	3
1 MANUFACTURER .....	4
2 RISKS AND DANGERS .....	5
2.1 Symbols shown .....	5
2.2 Warnings and danger warnings .....	6
2.3 Noisiness.....	7
2.4 User obligations .....	7
2.5 Transport and unpacking .....	7
3 DESCRIPTION OF THE MACHINE AND OPERATING CYCLE .....	8
3.1 Description .....	8
3.2 Operation cycle .....	8
3.3 Other characteristics .....	9
4 INSTALLATION .....	11
4.1 Electrical connection .....	11
4.2 Hopper connection.....	11
4.3 Cooling water connection (ONLY FOR HT MODELS) .....	12
5 HUMAN MACHINE INTERFACE .....	13
5.1 ATR safety thermoregulator .....	17
6 OPERATIONAL PROBLEMS AND POSSIBLE REMEDIES .....	18
7 MAINTENANCE .....	19
7.1 Ordinary .....	19
8 MACHINE DISPOSAL .....	20
9 WARRANTY .....	21
10 ATTENTION.....	22

## 1 MANUFACTURER

Company name:	Ferlin Plastics Automation
Legal and administrative residence:	Rudolf Dieselstraat 15A 7442DR Nijverdal (NL)
Telephone:	+31 (0)548 745 370
e-mail:	info@ferlin.nl
Chamber of Commerce registration number:	05034007
Tax code and VAT number:	NL805065507B01

### Assistance Service

Tele: +31 (0)548 745 370  
e-mail: [service@ferlin.nl](mailto:service@ferlin.nl)

Manufactured by:

*Manufacturing company name:*

*Legal and administrative residence:*

*Chamber of Commerce registration number:*

*Tax code and VAT number:*

*NEW OMAP s.r.l.*

*Via A. Volta 1/C*

*35020 LEGNARO (Padova) - ITALY*

*CCIAA PD 366924*

*04158840282*

# 2 RISKS AND DANGERS

## 2.1 Symbols shown

Table 2.1 shows the risks for the operator together with the mandatory signs regarding the use of personal protective equipment to be worn when using the machine.

Table 2.1: risks to the user



**GENERIC DANGER**



**DANGEROUS ELECTRICAL VOLTAGE**



**DANGER OF BURNS**



**SAFETY FOOTWEAR**



**PROTECTIVE GLOVES**



**PROTECTIVE VISOR**

---

## 2.2 Warnings and danger warnings

### Filter cleaning

Filter cleaning must be performed with the machine stopped and after the blower has stopped.

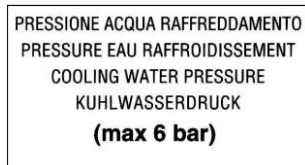
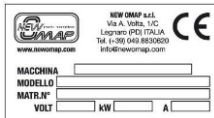
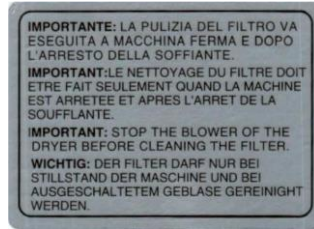

### Opening the side panel of the machine

Operating with the side panel open is very risky. Therefore make sure that the electrical circuit is suitably sectioned.

### Presence of multiple levels of tension

Pay the utmost attention even with the panel open in Section.

### Presence of compressed air

Make sure that there are no leaks in the compressed air circuit which is essential for controlling the pneumatic valves/

### Machine plate

Figure 2.5 shows the plate data indelibly so that they cannot be modified or eroded over time.

### Cooling water pressure

Figure 2.6 indicates the presence of a cooling circuit which is not mandatory in the installations of MD type dehumidifiers.

### Dew point control

Figure 2.7 indicates the presence of a probe for measuring the dew point of the air entering the hopper. In case of replacement, handle the probe with extreme caution.

### 2.3 Noisiness

The noise level is measured in free field at 1 m from the source and 1.5 m from the ground and is less than 80 dB or below the legal limits. Even if the limit threshold is not exceeded, it is still advisable for the operator to use hearing protection devices (earplugs, headphones).

### 2.4 User obligations

The operator is obliged to:

- prohibit non-workers from approaching the operating range of the machine in operation;
- do not remove the risk warnings provided;
- use protective gloves to avoid cuts and / or burns;
- use protective mask to avoid toxic inhalations;
- never rest your hands on the edges of the hopper when its lid is open;
- strictly dehumidify only non-toxic material;
- equip the system (if necessary) with a special extractor hood;
- never remove the safety devices installed on the machine;
- do not smoke near the dehumidifier;
- arrange fire prevention measures in the vicinity of the dehumidifier;
- carry out maintenance operations on the machine EXCLUSIVELY with the machine stopped and disconnected from the power supply (disconnecting switch on the machine board open);
- do not remove the filters from the machine in operation;
- do not use the machine outdoors (outdoors);
- if it is necessary to move the machine, move it only with the hopper empty.

### 2.5 Transport and unpacking

The means of loading, unloading and transport must comply with the regulations in force. The machine must be handled by lifting it from the bottom, inserting the tips of the lifting trolley (figure 2.8). It is recommended NOT to use ropes or chains to harness the packaging. Before lifting, check that nothing can fall during lifting operations.



During unpacking operations, the operator must use protective gloves and clothing to avoid possible cuts or grazes due to the presence of wooden parts and plastic bands. The machine is delivered inside a carton or on a wooden pallet. Inside there are:

- The dehumidification unit;
- The insulated hopper with the connection pipes;
- The connection base
- The trolley with the suction drawer
- The use and maintenance manual.

### 3 DESCRIPTION OF THE MACHINE AND OPERATING CYCLE

#### 3.1 Description

The dehumidifiers have the function of removing moisture from the plastic material in non-toxic granules placed inside the connected hopper; within them they are made up of the following fundamental elements:

- dehumidification wheel;
- process and regeneration air blowers;
- heating resistors for the process and for regeneration;
- command and control panel.

#### 3.2 Operation cycle

Figure 3.1 illustrates the work cycle as a whole; inside the alveolar cavity wheel 3 treatments are performed simultaneously:

- 1) the process that occupies half of the cavities and consists of introducing dehumidified air into the hopper. The blower circulates air within a closed circuit, which is dehumidified and subsequently brought to the desired temperature through the process resistance;

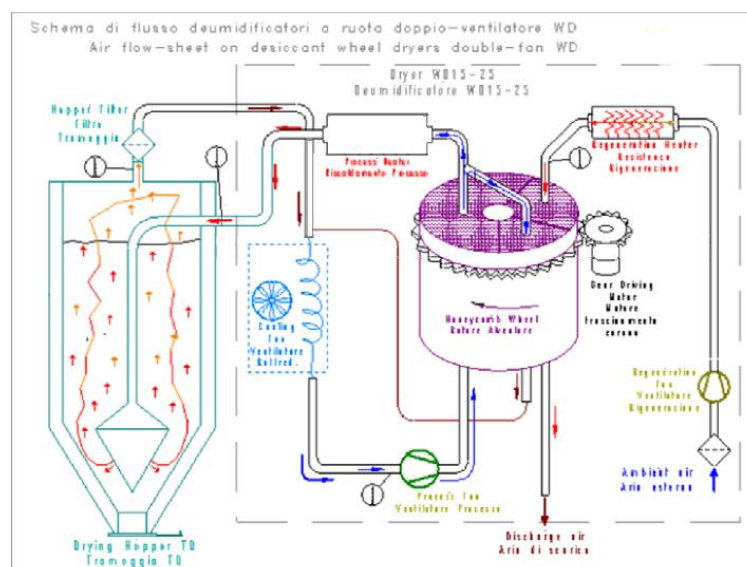



- 2) regeneration where part of the cavities release moisture to the heated ambient air with which it comes into contact;
- 3) the cooling necessary to prepare the wheel cavities to carry out the process step again.

The process is able to maintain low-variable dew point values over time thanks to the cyclicity provided by the movement of the wheel. The technical characteristics and the projections of the machine are grouped in table3.1.

### 3.3 Other characteristics

Specifications	Unit	FED 15/30	FED 15/30HT	FED 20/50	FED 20/50HT
Process temperature	°C	50-150	50-170	50-150	50-170
Air flow	M3/h	15	15	20	20
Blower power	kW	0,85	0,85	0,85	1,5
Process heating	kW	1,6	1,6	1,6	1,6
Regeneration heating	kW	1,0	1,0	1,0	1,0
Total installed power	kW	2,7	2,7	2,7	2,7
Voltage	V	230V 1 50Hz	230V 1 50Hz	230V 1 50Hz	230V 1 50Hz
Hopper volume	Dm3	30	30	50	50

Specifications	Unit	FED 25/75	FED 25/75HT	FED 30/100	FED 30/100HT
Process temperature	°C	50-150	50-170	50-150	50-170
Air flow	M3/h	150	150	150	150
Blower power	kW	0,85	0,85	0,85	1,5
Process heating	kW	1,6	1,6	1,6	1,6
Regeneration heating	kW	1,0	1,0	1,0	1,0
Total installed power	kW	2,7	2,7	2,7	2,7
Voltage	V	230V 1 50Hz	230V 1 50Hz	230V 1 50Hz	230V 1 50Hz
Hopper volume	Dm3	75	75	100	100

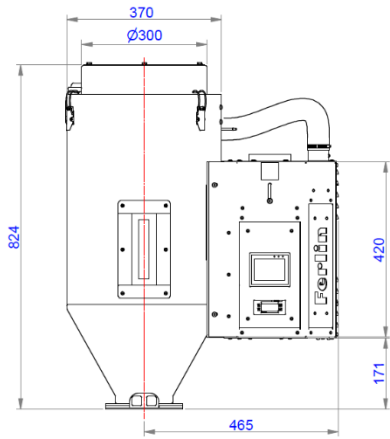

FED 15/30 (HT)

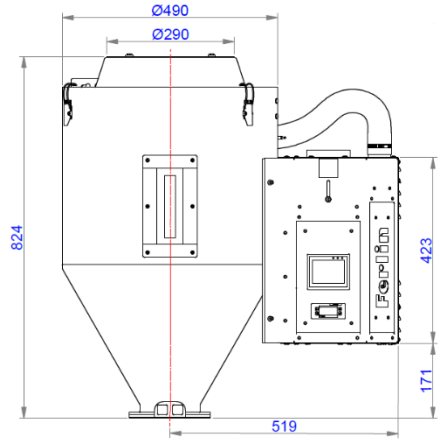

FED 20/50 (HT)

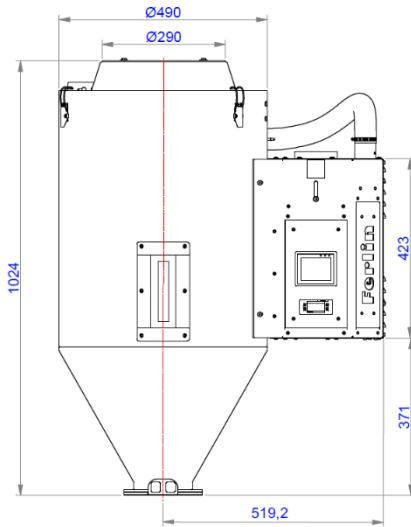

FED 25/75 (HT)

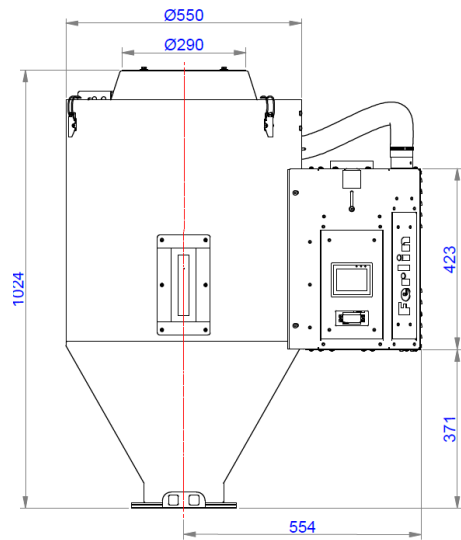

FED 30/100 (HT)

## 4 INSTALLATION

The machine must be installed by expert personnel and in full compliance with all applicable regulations. The installation interventions must be carried out in conditions of absolute safety both for those who carry out the work and for those in the vicinity. To achieve this, the workers must be equipped with all the necessary devices, which delimit the work area with signaling tapes and have danger signs at strategic points. The machine has been designed to be able to work with the following limit values:

- Room temperature +5°C +40°C
- Storage temperature -10°C +50°C
- Relative humidity without condensation 30% 95%
- Maximum altitude 2000 m s.l.m.

### 4.1 Electrical connection

*The electrical connection must be carried out by expert personnel. Check the machine plate data and verify that the line is suitable for the power of the machine. Prepare an adequate protection and sectioning system upstream of the machine as well as connect an efficient earth system.*

The machine must be connected using the cable on the machine. If it is necessary to replace it, the new cable must have the same characteristics. Also check that the voltage and frequency of the power supply line correspond to those indicated on the plate of the dehumidifier. Having checked everything, power up the machine. The machine can be powered in 2 ways:

- via PLUG-SOCKET: The assembly of the device running with power supply from an electrical socket requires the installation on the power cable of a plug compliant with current legislation, in the country of use;
- from EXTERNAL ELECTRIC SWITCH BOARD: the feeding cable must be tied up to the switchboard with an extra installation of safety devices mounted upstream (thermal-magnetic circuit breakers and earth leakage CB). It is assumed that the maximum short-circuit current is 10kA.

### 4.2 Hopper connection

For these sizes of dehumidifiers, the hopper is always connected via pipes fixed at the end by metal clamps since and encumbrance of the 2 organs do not allow direct connection. The drying unit is always attached to the drying hopper.

#### **4.3 Cooling water connection (ONLY FOR HT MODELS).**

The couplings for the cooling water connection have a diameter of 1/4 inch.

The pressure must not be greater than 3 bar. The cooling water temperature must be below or equal to 18 ° C.

## 5 HUMAN MACHINE INTERFACE

The dehumidifier is equipped with a graphic (TOUCH SCREEN) for managing the machine status and any alarms.



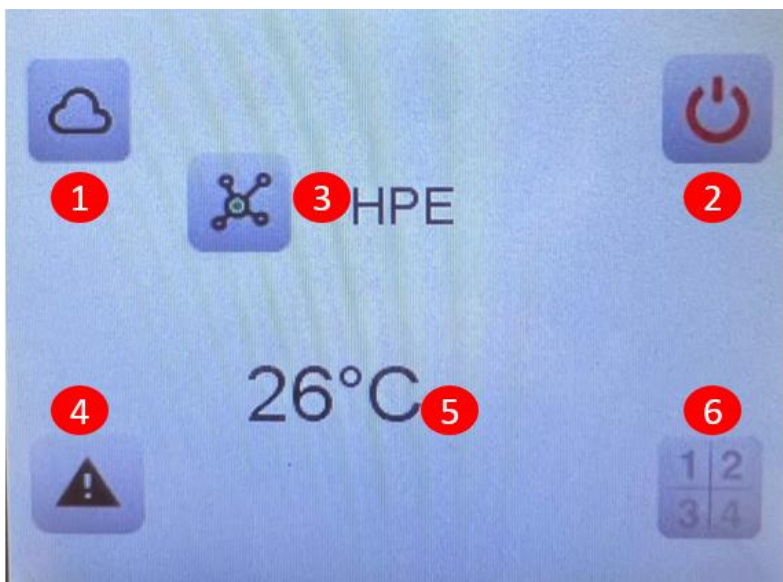

When the machine is turned on, after a few seconds, the display shows the screen in which describes the status of the machine, the type of material and the actual operating temperature.



- 1) FerlinBridge
- 2) State of operation
- 3) Material recipes
- 4) Alarm
- 5) Current temperature

6) Main pages

**Operating status:**

1) if the machine status is in start pressing this button  once changes the status to ventilation  after about 10 minutes (cooling time) the machine stops and the status is changed to stop 

 START

 STOP

 VENTILATION

2) **Receiver:** If the machine has the receiver (Hopper Loader) MOVAC Easy-4 or MOVAC Easy-5 physically connected, press the icon the figure 5.3 is shown. Through the icon turns on or off and it is possible to change the parameters of the a & b & c & d receiver.

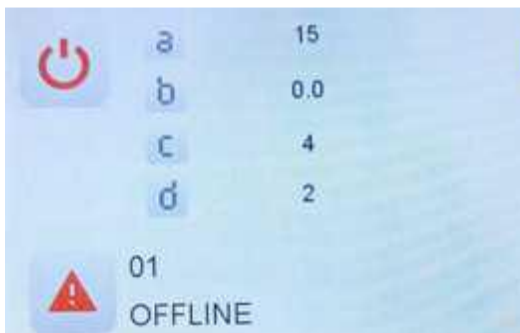

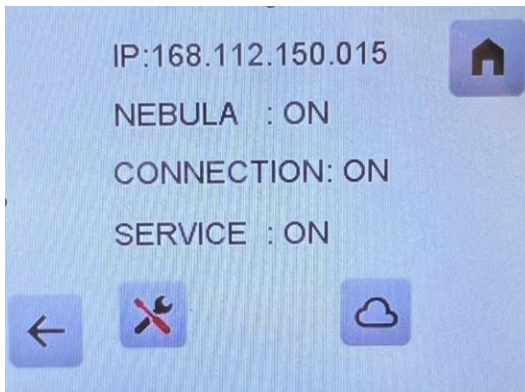

OFFLINE: it means that the receiver is not connected.

3) **Manage FerlinBridge:** To check the FerlinBridge status and change the activation, press the icon. On this page, the user can set the IP of the machine, the status of NEBULA, the internet connection and the service status for remote maintenance. Pressing the icon with the Password 8 8 8 8 you set the status of NEBULA and SERVICE.





4) **Alarm:** Pressing the icon  (reset the alarm), which specifies the number, date and time of the alarm.



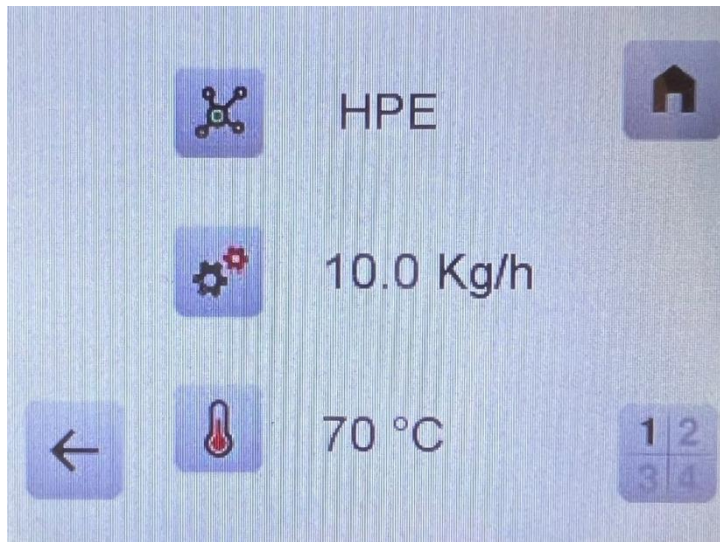

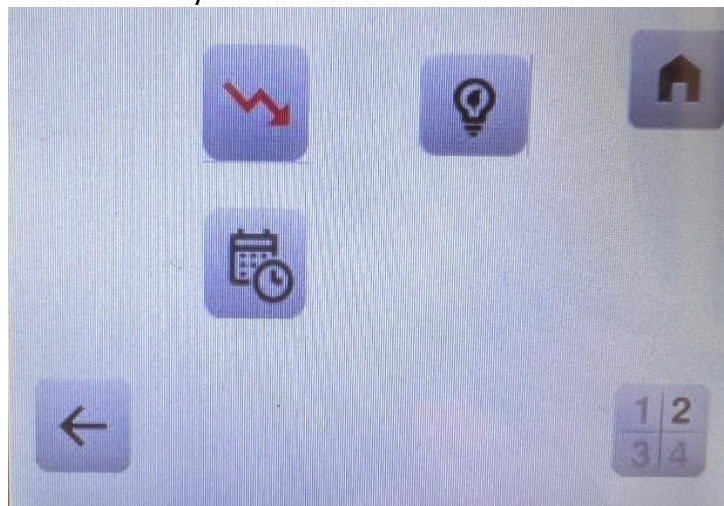

5) **Main pages:** The Touch screen contains 4 main pages pressing the icon  shows the first page.

- I. On this page the user can change the type of material (the recipe) by pressing once on the material icon. Up and down arrows for choice of recipe (material). When the user confirms a recipe, the material treatment temperature and the flow rate in kg / h for the material are automatically written, which will vary according to the size of the hopper and the model of the dehumidifier. The user can change the flow rate and temperature according to his needs pressing the icon  can change the temperature and on the icon .



- II. From the second page, the user can activate or deactivate the RCE (anti-stress) function , the energy function  for energy saving of the machine and the weekly calendar  of the machine.



-  RCE deactivated
-  RCE activated
-  Weekly calendar active
-  Weekly calendar disabled
-  Energy saving (0)
-  Energy saving (1)
-  Energy saving (2)



- III. The third page contains the machine data; Model, serial number, software version and date and time.

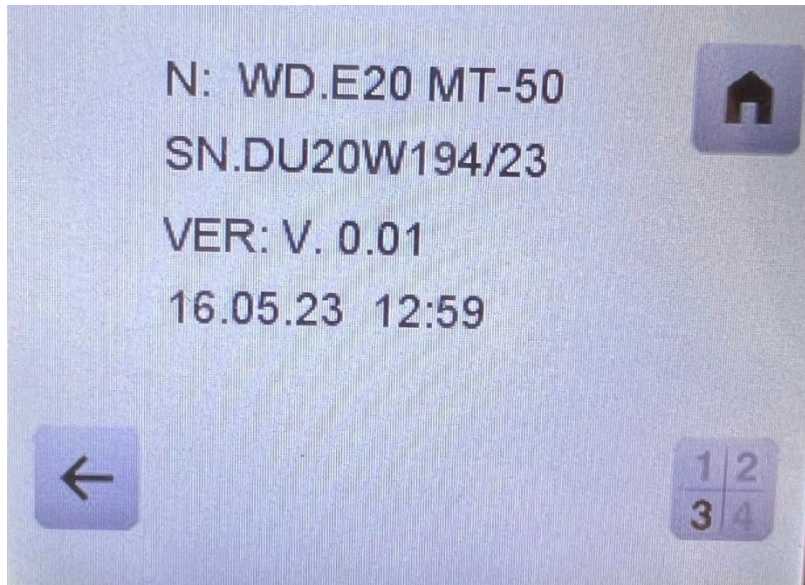

- IV. The fourth page shows all temperatures of the machines.
- RT : the actual operating temperature.
  - REG: the regeneration temperature.
  - RAT: return air temperature.
  - RCE: the RCE temperature (hopper area return)
  - TPT: regeneration exhaust air temperature (to manage the energy function)
  - PT ACTIVATION %: the percentage of activation of the process resistor.
  - RE ACTIVATION%: the percentage of activation of the regeneration resistor.

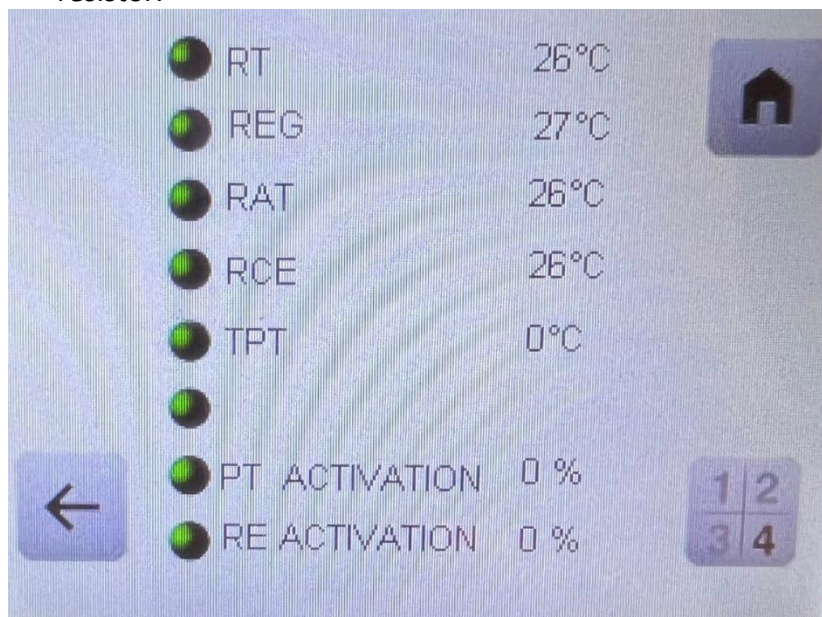



Pressing each icon on the screen shows the graph that describes the temperature trend over time.

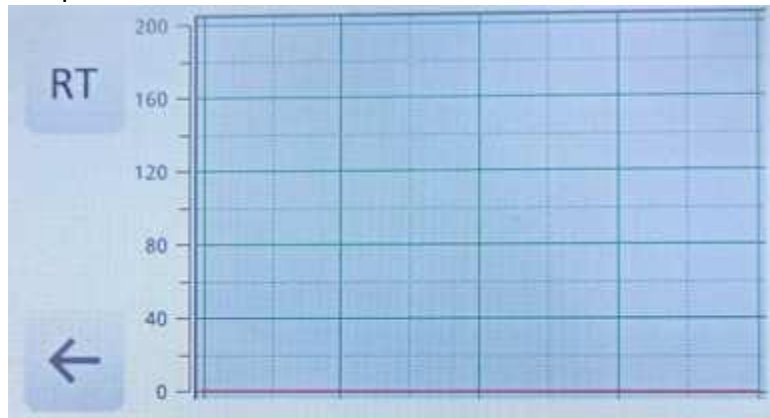

### 5.1 Safety thermoregulator

The thermoregulator display shows two temperature values: the larger green one represents the temperature detected by the instrument while the smaller red one represents the set for which there is an alarm. To change the alarm set, simply press the “\_” button to increase and “\_” to decrease the alarm temperature value. When the alarm value is reached, the heating of the machine stops as the automatic stop of the dehumidifier is implemented. The set alarm set must be 25 ° C higher than the process set in the electronic control board of the machine to avoid untimely trips due to temporary temperature peaks inside the process tower that may occur during normal operation.



## 6 OPERATIONAL PROBLEMS AND POSSIBLE REMEDIES

Before asking e-service, verify the possible remedies in the following table.

<b>Problem</b>	<b>Remedy</b>
<b>Alarm 01 proces over temperature</b>	Clean hopper filter. Check process blower and pipes conditions as well as process temp. selection. Check if SSRP works properly.
<b>Alarm 02 regeneration over temperature</b>	Clean regeneration filter. Check regeneration blower and pipe conditions. Check if SSRR works properly
<b>Alarm 03 Safety thermoregulator</b>	Proceed as indicated for alarm 01
<b>Alarm 04 Contactor</b>	Check if KM works properly
<b>Alarm 08 Return air temperature</b>	Turn RCE function on
<b>Alarm 09 Process heating missing</b>	Check KM FU2 SSRP HEP
<b>Alarm 10 Regeneration heating missing</b>	Check KM FU3 SSRR HER
<b>Alarm 13 Process probe damaged</b>	Replace probe ST1
<b>Alarm 14 Regeneration probe damaged</b>	Replace probe ST2
<b>Alarm 16 Return air probe damaged</b>	Replace probe ST3
<b>Alarm 18 R.C.E. probe damaged</b>	Replace probe ST4
<b>Alarm 19 Dew point probe damaged</b>	Replace probe D.P.
<b>Alarm 20 Dew Point alarm (dew point temp.higher than the set)</b>	Automatically disappears when the dew point set is reached. If it does not disappear, check the rotor functioning
<b>Alarm 22 Cartridge movement micro switch</b>	Check FU4, M2 and the microswitch
<b>Alarm 27 T1 process thermal switch</b>	1) Check SSRP 2) Check for clogging of filter and pipes thermal switch T1
<b>Alarm 28 T2 regeneration thermal switch.</b>	1) Check SSRR 2) Check for clogging of filter and pipes thermal switch T2
<b>Alarm 44 Switch off not properly executed</b>	Press STOP. Next time let the ventilation after switch off fan run for the time due (~20 minutes)

## 7 MAINTENANCE

Machine maintenance must be carried out by expert personnel and in full compliance with all applicable regulations. Maintenance interventions must be carried out in conditions of absolute safety both for those who perform the work and for those in the vicinity. To achieve this, the workers must be equipped with all the devices necessary to operate safely, which delimit the work area with signaling tapes and have danger signs in the points at risk. Carry out maintenance operations with the machine off.

### 7.1 Ordinary

The routine maintenance program is established taking into account the optimal conditions of the machine, its way of working and the environment in which it normally operates. It is therefore essential to establish and follow a regular inspection and maintenance program. Ferlin Plastics Automation declines any responsibility for damage to persons and / or things deriving from non-compliance with the aforementioned standards or from irregular and / or improper use of the machine.

The dehumidifier as well as the dehumidification hopper are equipped with an easy-to-remove black cartridge filter (1) to prevent the dust of the dehumidified material from coming into contact with the heating elements or with the inside of the blower. There is also a paper filter for the regeneration process (2). These filters must never be removed with the appliance running. It is advisable to clean the dehumidifier-hopper filters on a daily basis, by switching off the machine and cleaning by means of a blowing process. Dirty and clogged filters reduce the performance of the machine. It is also necessary to carefully clean the hopper every time the material is changed, to prevent any deposits from mixing with the new type of plastic. It is therefore necessary to turn off the machine, unload the material and after opening the lid, remove the air duct and carefully clean the inside of the hopper.

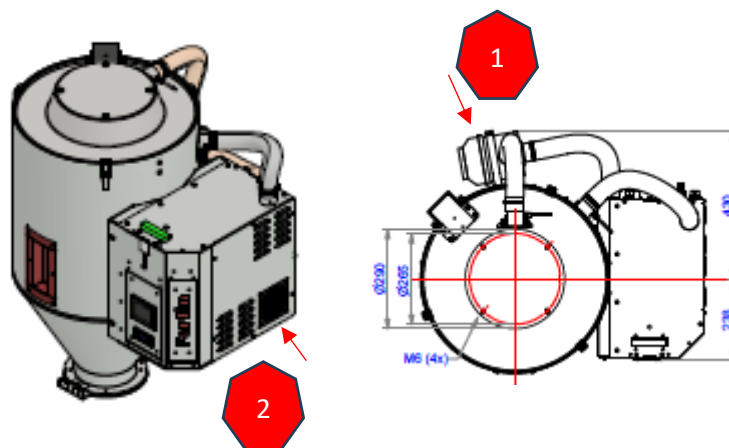

## 8 MACHINE END OF LIFE (RECYCLE)

When the machine needs to be eliminated, it is necessary to uninstall it from the system and place it internally in the warehouse until it is disposed of in a suitable environment, taking care to apply a sign with the wording:

**MACHINE NOT AVAILABLE. TO BE DISPOSED**

Before disposing please always get in touch with Ferlin Plastics Automation. In many cases we can give a refund for a used machine. This also enables us to recycle the machine as much as possible.



*WE BELIEVE IN A*  
**BRIGHT AND**  
**SUSTAINABLE FUTURE**  
*FOR PLASTICS*

## **9 WARRANTY**

Ferlin Plastics Automation (hereinafter referred to as the SELLER) guarantees the BUYER, but not its ASSIGNORS, the machinery produced under the SALE contract, for a period of 12 months from the invoice date. The guarantee is applied for the free repair or replacement of parts found to be unserviceable due to faults or defects in material, construction or workmanship, provided that these parts are delivered ex factory of the SELLER. The general terms and conditions of delivery formulated by Metaalunie are applicable. In the event of a contradiction between the general terms and conditions of delivery of the Metaalunie and this manual, the general terms and conditions of delivery shall apply

In addition to the repair and replacement referred to above, the SELLER does not have any obligation and the BUYER is in particular excluded from the right to demand the termination of the SALE contract or any compensation for damages. If the repairs and replacements must be made in the place where the machine is installed, the travel (round trip) and accommodation costs of the SELLER's technicians will be billed to the BUYER based on the specially published rates.

In the execution, the SELLER company uses materials, organs and mechanisms of type, state and quality deemed at its sole discretion, suitable for the machine to be built, even after receipt of the order and can make constituent changes to the machines, always at its sole discretion. , the appropriate improvements.

The SELLER company will not be responsible for defects deriving from materials or designs supplied by the BUYER. The SELLER will be responsible only for defects relating to the conditions of use provided for in the use and maintenance manual and if the machine is used correctly and not for defects due to causes that arise after delivery. The warranty does not extend to failures or breakages resulting from natural wear and tear, negligent maintenance, inexperience, neglect or misuse of the machine by the BUYER and ceases if payments are not made by the BUYER at the agreed deadlines or if the machine, or parts of it have been modified or repaired without the written authorization of the SELLER.

The warranty of the electrical and electronic parts supplied with the machine ends with its regular start-up. In any case, any legal action for defects, deficiencies in quality, lack of performance or of certain requirements for any other reason or claim must be brought to the BUYER under penalty of forfeiture, within 12 months from the invoice date and will be or will become unacceptable when the BUYER is in arrears in the payment, even of a single instalment. In the event of a dispute, Dutch law will be competent.

## 10 ATTENTION

It is absolutely forbidden to connect the compressed air pipes to the fitting dedicated to measuring the DEW POINT shown in the photos in the below picture. Failure to comply with this indication will result in the loss of the warranty of the device.

